



SERIE

I

CILINDRI TONDI
ROUND CYLINDERS



ARTEC[®]
PNEUMATIC COMPONENTS

CARATTERISTICHE TECNICHE - TECHNICAL CHARACTERISTICS

Pressione di esercizio <i>Working pressure</i>	1 ÷ 10 bar
Temperatura di esercizio <i>Working temperature</i>	0 ÷ +80°C (-20°C con aria secca - <i>with dry air</i>) 0 ÷ +150°C (con guarnizioni per alte temperature - <i>with high temperature seals</i>)
Versioni - Versions	semplice effetto, doppio effetto, stelo passante - <i>single acting, double acting, double rod</i>
Alesaggi - Bores	∅ 32 - 40 - 50 - 63
Corse - Strokes	vedere tabelle corse standard - <i>see standard stroke tables</i>
Fluido - Fluid	aria compressa filtrata, non lubrificata - <i>compressed filtered, non lubricated air</i>

CARATTERISTICHE COSTRUTTIVE - CONSTRUCTIVE CHARACTERISTICS

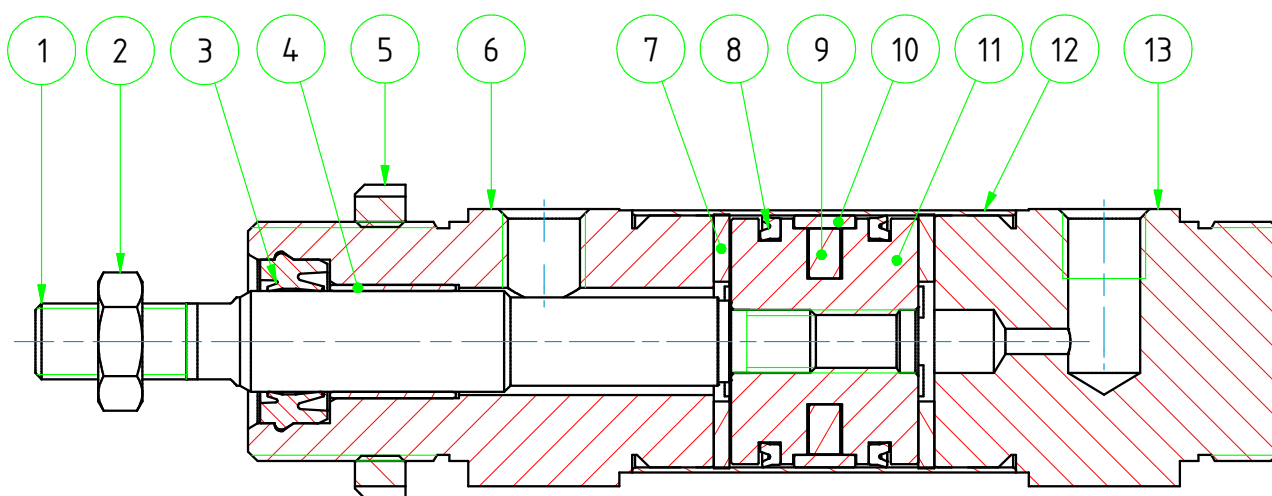
①	Stelo - Rod	acciaio C 45 cromato - <i>C45 chromed steel</i>
② ⑤	Dado - Nut	acciaio zincato - <i>zinc coated steel</i>
③ ⑧	Guarnizioni - Seals	poliuretano - <i>polyurethane</i>
④	Boccola - Bush	bronzo sinterizzato - <i>sintered bronze</i>
⑥ ⑬	Testate - Covers	alluminio anodizzato - <i>anodized aluminium</i>
⑫	Tubo - Tube	acciaio inox AISI 304 - <i>stainless steel AISI 304</i>
⑨	Magnete - Magnet	plastroferrite - <i>rubber magnet</i>
⑩	Pattino di guida - Guide ring	PBT+PTFE
⑪	Pistone - Piston	alluminio - <i>aluminium</i>
⑦	Paracolpo - Bumper	neoprene



CHIAVE DI CODIFICA
KEY CODE

I D M		0 3 2 . 0 5 0 . G S . M			
		ALESAGGIO - BORE (Ø)	CORSA - STROKE (mm)	OPZIONE - OPTION	
		032-040-050-063	vedere tabelle corse std see std stroke tables	W con ammortizzo with cushioning	
		VERSIONE - VERSION		OPZIONE - OPTION	
		P stelo passante double rod		X3 stelo in acciaio inox AISI 303 AISI 303 stainless steel rod	
		VERSIONE - VERSION		X6 stelo in acciaio inox AISI 316 AISI 316 stainless steel rod	
		M magnetico magnetic		STELO - ROD	
		non magnetico non-magnetic		maschio - male Ø32 M10x1,25 Ø40 M12x1,25 Ø50-63 M16x1,5	
		VERSIONE - VERSION		M1 maschio - male Ø32 M10x1,5 Ø40 M12x1,75 Ø50-63 M16x2	
		S semplice effetto molla anteriore single acting front spring		GUARNIZIONI - SEALS	
		SE semplice effetto molla posteriore single acting rear spring		GS guarnizioni standard standard seals	
		D doppio effetto double acting		VR guarnizione stelo per alte temperature high temperature rod seal	
SERIE - SERIES				VA tutte le guarnizioni per alte temperature all seals for high temperature	
		I tubo tondo cianfrinato crimped round tube			

FORZE TEORICHE DI TRAZIONE (P=6bar)
THEORETICAL FORCES OF TRACTION (P=6bar)

		Ø	32	40	50	63
IDM	SPINTA THRUST	[N]	483	753	1178	1870
	TRAZIONE TRACTION	[N]	415	633	990	1682
IDMP	SPINTA THRUST	[N]	415	633	990	1682
	TRAZIONE TRACTION	[N]	415	633	990	1682

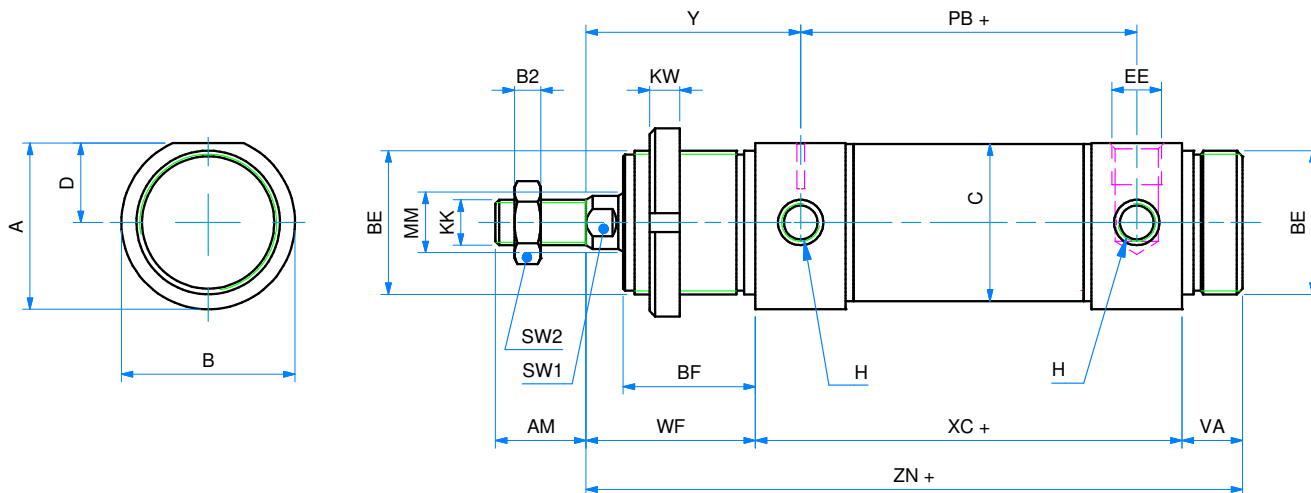
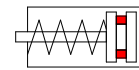
SEMPLICE EFFETTO MAGNETICO - MOLLA ANTERIORE
SINGLE ACTING MAGNETIC - FRONT SPRING

Note: dado stelo e ghiera compresi nella fornitura
 Note: rod nut and slotted nut included in the supply

DIMENSIONI - DIMENSIONS

	32	40	50	63
ø	32	40	50	63
A	36,5	44	55	67,5
AM	20	24	32	32
ø B	38	46	57	70
BE	M30x1,5	M38x1,5	M45x1,5	M45x1,5
BF	30	35	38	38
C	33,6	41,6	52,4	65,4
CH	10	12	16	16
D	17,5	21	26,5	32,5
EE	1/8" G	1/4" G	1/4" G	3/8" G
H	M8x1	M10x1	M12x1,5	M14x1,5
KK	M10x1,25	M12x1,25	M16x1,5	M16x1,5
ø MM	12	16	20	20
PB +	78	89	96	98
VA	14	16	18	18
WF	38	45	50	50
XC +	96	113	120	124
Y	47	57	62	63
ZN +	148	174	188	192

+ = lunghezza corsa - stroke length

ø CORSE STANDARD - STANDARD STROKES

032 10 - 25 - 50

040 10 - 25 - 50

050 10 - 25 - 50

063 10 - 25 - 50

SEMPLICE EFFETTO MAGNETICO - MOLLA POSTERIORE

ISEM

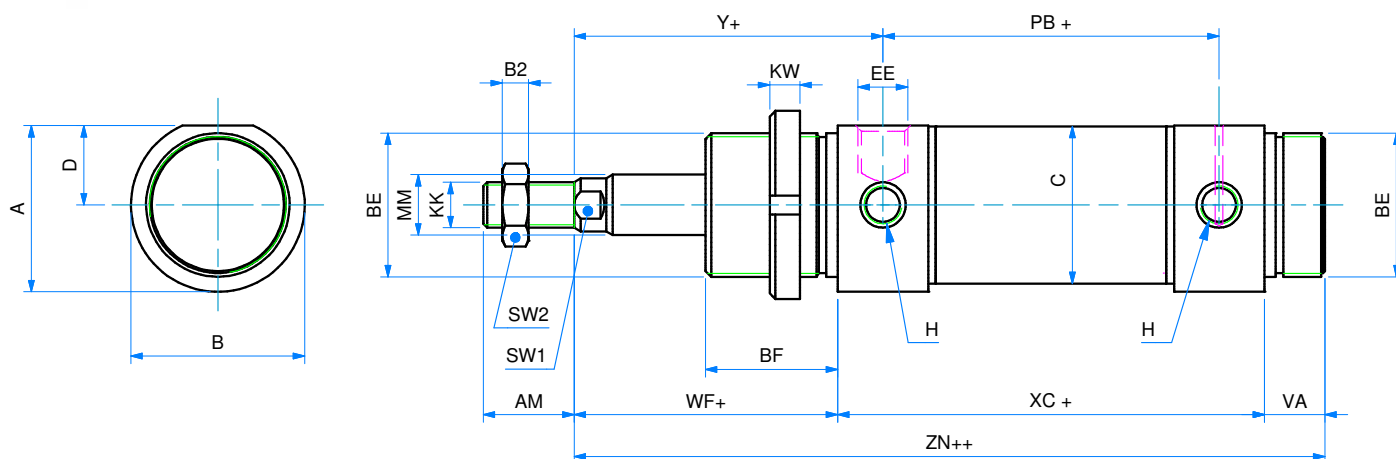
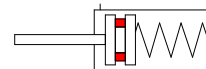
SINGLE ACTING MAGNETIC - REAR SPRING

Note: dado stelo e ghiera compresi nella fornitura
 Note: rod nut and slotted nut included in the supply

DIMENSIONI - DIMENSIONS

Ø	32	40	50	63
A	36,5	44	55	67,5
AM	20	24	32	32
Ø B	38	46	57	70
BE	M30x1,5	M38x1,5	M45x1,5	M45x1,5
BF	30	35	38	38
C	33,6	41,6	52,4	65,4
CH	10	12	16	16
D	17,5	21	26,5	32,5
EE	1/8" G	1/4" G	1/4" G	3/8" G
H	M8x1	M10x1	M12x1,5	M14x1,5
KK	M10x1,25	M12x1,25	M16x1,5	M16x1,5
Ø MM	12	16	20	20
PB +	78	89	96	98
VA	14	16	18	18
WF +	38	45	50	50
XC +	96	113	120	124
Y +	47	57	62	63
ZN ++	148	174	188	192

+ = lunghezza corsa - stroke length

++ = 2x lunghezza corsa - 2x stroke length

Ø CORSE STANDARD - STANDARD STROKES

032 10 - 25 - 50

040 10 - 25 - 50

050 10 - 25 - 50

063 10 - 25 - 50

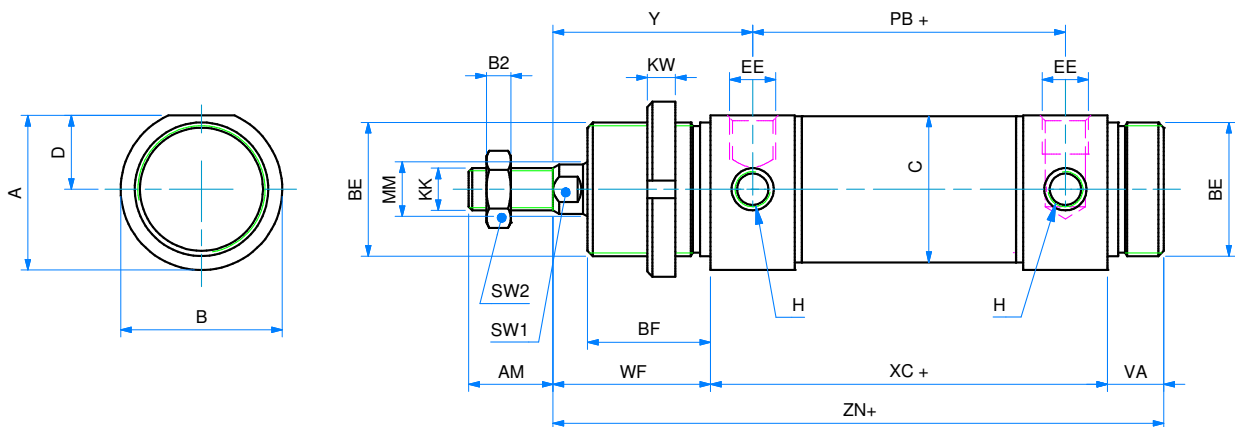
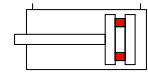
DOPPIO EFFETTO MAGNETICO
DOUBLE ACTING MAGNETIC

Note: dado stelo e ghiera compresi nella fornitura
 Note: rod nut and slotted nut included in the supply

DIMENSIONI - DIMENSIONS

	32	40	50	63
ø	32	40	50	63
A	36,5	44	55	67,5
AM	20	24	32	32
ø B	38	46	57	70
BE	M30x1,5	M38x1,5	M45x1,5	M45x1,5
BF	30	35	38	38
C	33,6	41,6	52,4	65,4
CH	10	12	16	16
D	17,5	21	26,5	32,5
EE	1/8" G	1/4" G	1/4" G	3/8" G
H	M8x1	M10x1	M12x1,5	M14x1,5
KK	M10x1,25	M12x1,25	M16x1,5	M16x1,5
ø MM	12	16	20	20
PB +	78	89	96	98
VA	14	16	18	18
WF	38	45	50	50
XC +	96	113	120	124
Y	47	57	62	63
ZN +	148	174	188	192

+ = lunghezza corsa - stroke length

ø CORSE STANDARD - STANDARD STROKES

032	10 - 25 - 50 - 80 - 100 - 125 - 160 - 200 - 250 - 320 - 400 - 500 - 600 - 700 - 800 - 900 - 1000
040	10 - 25 - 50 - 80 - 100 - 125 - 160 - 200 - 250 - 320 - 400 - 500 - 600 - 700 - 800 - 900 - 1000
050	10 - 25 - 50 - 80 - 100 - 125 - 160 - 200 - 250 - 320 - 400 - 500 - 600 - 700 - 800 - 900 - 1000
063	10 - 25 - 50 - 80 - 100 - 125 - 160 - 200 - 250 - 320 - 400 - 500 - 600 - 700 - 800 - 900 - 1000

DOPPIO EFFETTO MAGNETICO AMMORTIZZATO

IDM-W

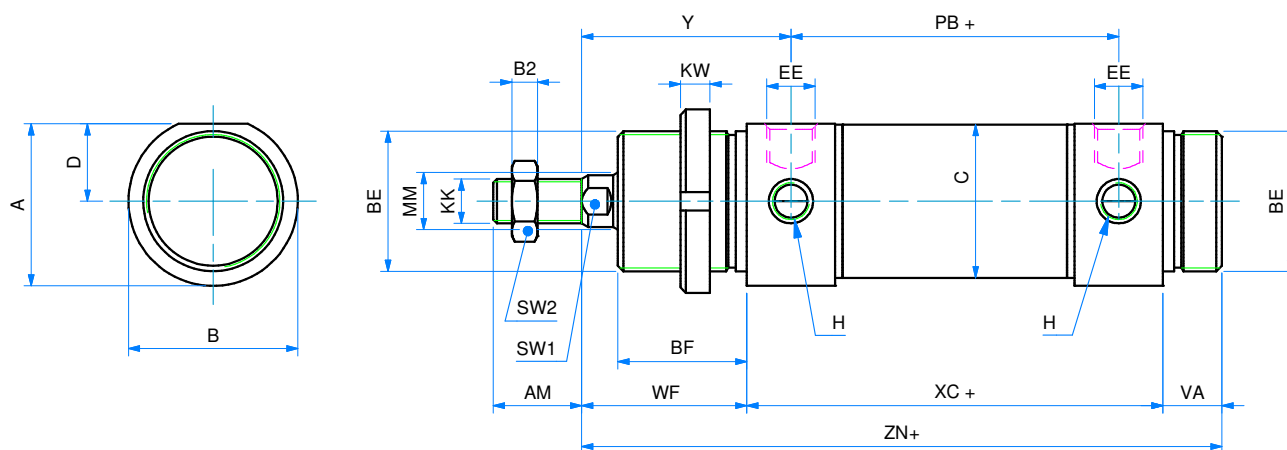
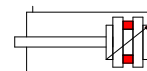
DOUBLE ACTING MAGNETIC CUSHIONED

Note: dado stelo e ghiera compresi nella fornitura
 Note: rod nut and slotted nut included in the supply

DIMENSIONI - DIMENSIONS

	32	40	50	63
A	36,5	44	55	67,5
AM	20	24	32	32
ø B	38	46	57	70
BE	M30x1,5	M38x1,5	M45x1,5	M45x1,5
BF	30	35	38	38
C	33,6	41,6	52,4	65,4
CH	10	12	16	16
D	17,5	21	26,5	32,5
EE	1/8" G	1/4" G	1/4" G	3/8" G
H	M8x1	M10x1	M12x1,5	M14x1,5
KK	M10x1,25	M12x1,25	M16x1,5	M16x1,5
ø MM	12	16	20	20
PB +	78	89	96	98
VA	14	16	18	18
WF	38	45	50	50
XC +	96	113	120	124
Y	47	57	62	63
ZN +	148	174	188	192

+ = lunghezza corsa - stroke length

0 CORSE STANDARD - STANDARD STROKES

032 25 - 50 - 80 - 100 - 125 - 160 - 200 - 250 - 320 - 400 - 500 - 600 - 700 - 800 - 900 - 1000

040 25 - 50 - 80 - 100 - 125 - 160 - 200 - 250 - 320 - 400 - 500 - 600 - 700 - 800 - 900 - 1000

050 25 - 50 - 80 - 100 - 125 - 160 - 200 - 250 - 320 - 400 - 500 - 600 - 700 - 800 - 900 - 1000

063 25 - 50 - 80 - 100 - 125 - 160 - 200 - 250 - 320 - 400 - 500 - 600 - 700 - 800 - 900 - 1000

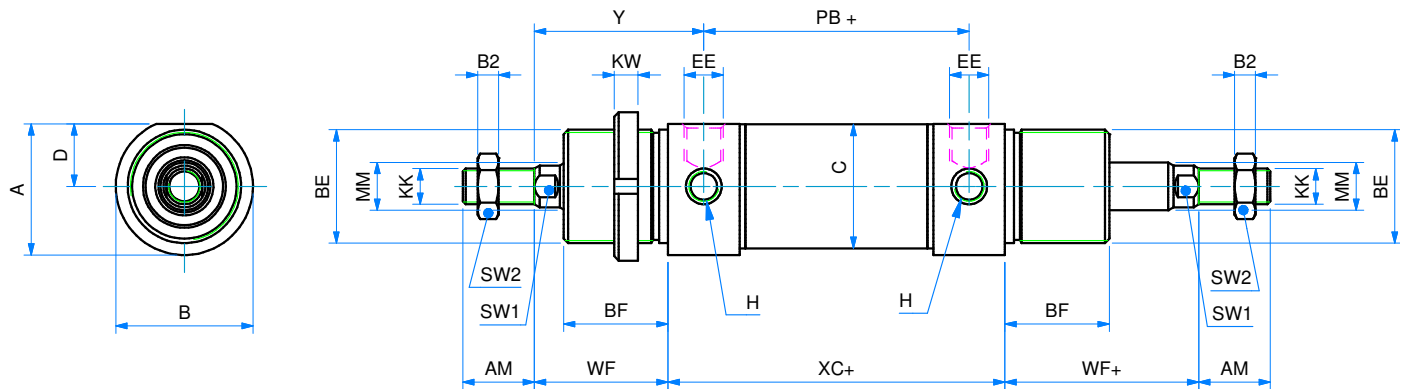
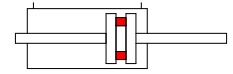
DOPPIO EFFETTO MAGNETICO STELO PASSANTE
DOUBLE ACTING MAGNETIC WITH DOUBLE ROD

Note: dado stelo e ghiera compresi nella fornitura
 Note: rod nut and slotted nut included in the supply

DIMENSIONI - DIMENSIONS

	32	40	50	63
ø	32	40	50	63
A	36,5	44	55	67,5
AM	20	24	32	32
ø B	38	46	57	70
BE	M30x1,5	M38x1,5	M45x1,5	M45x1,5
BF	30	35	38	38
C	33,6	41,6	52,4	65,4
CH	10	12	16	16
D	17,5	21	26,5	32,5
EE	1/8" G	1/4" G	1/4" G	3/8" G
H	M8x1	M10x1	M12x1,5	M14x1,5
KK	M10x1,25	M12x1,25	M16x1,5	M16x1,5
ø MM	12	16	20	20
PB +	78	89	96	98
WF	38	45	50	50
WF+	38	45	50	50
XC +	96	113	120	124

+ = lunghezza corsa - stroke length

++ = 2x lunghezza corsa - stroke length

ø CORSE STANDARD - STANDARD STROKES

032	10 - 25 - 50 - 80 - 100 - 125 - 160 - 200 - 250 - 320 - 400 - 500 - 600 - 700 - 800 - 900 - 1000
040	10 - 25 - 50 - 80 - 100 - 125 - 160 - 200 - 250 - 320 - 400 - 500 - 600 - 700 - 800 - 900 - 1000
050	10 - 25 - 50 - 80 - 100 - 125 - 160 - 200 - 250 - 320 - 400 - 500 - 600 - 700 - 800 - 900 - 1000
063	10 - 25 - 50 - 80 - 100 - 125 - 160 - 200 - 250 - 320 - 400 - 500 - 600 - 700 - 800 - 900 - 1000

DOPPIO EFFETTO MAGNETICO STELO PASSANTE AMMORTIZZATO

IDMP-W

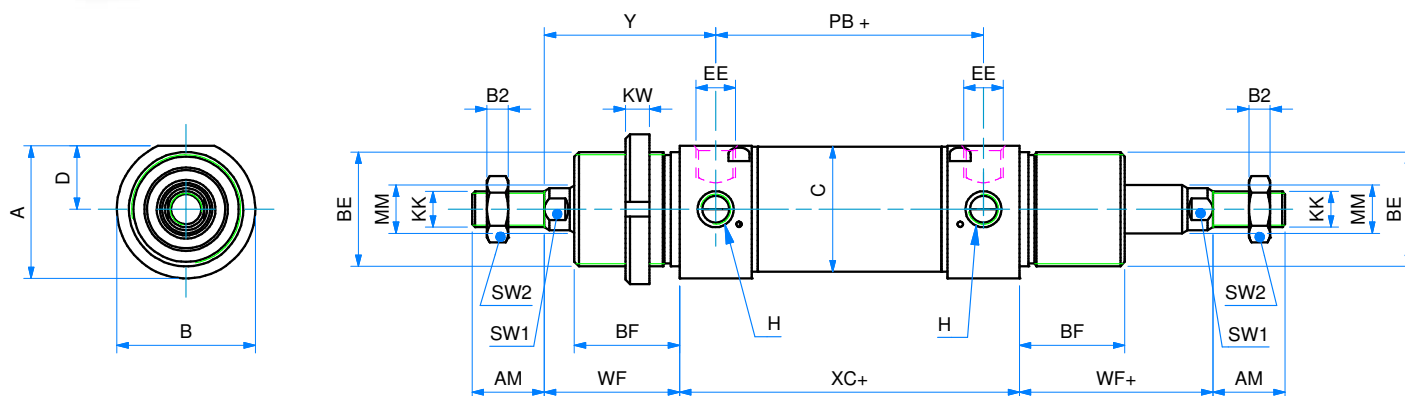
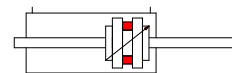
DOUBLE ACTING MAGNETIC CUSHIONED WITH DOUBLE ROD

Note: dado stelo e ghiera compresi nella fornitura

Note: rod nut and slotted nut included in the supply

DIMENSIONI - DIMENSIONS

	32	40	50	63
ø	32	40	50	63
A	36,5	44	55	67,5
AM	20	24	32	32
ø B	38	46	57	70
BE	M30x1,5	M38x1,5	M45x1,5	M45x1,5
BF	30	35	38	38
C	33,6	41,6	52,4	65,4
CH	10	12	16	16
D	17,5	21	26,5	32,5
EE	1/8" G	1/4" G	1/4" G	3/8" G
H	M8x1	M10x1	M12x1,5	M14x1,5
KK	M10x1,25	M12x1,25	M16x1,5	M16x1,5
ø MM	12	16	20	20
PB +	78	89	96	98
WF	38	45	50	50
WF+	38	45	50	50
XC +	96	113	120	124

+ = lunghezza corsa - stroke length

++ = 2x lunghezza corsa - stroke length

ø CORSE STANDARD - STANDARD STROKES

032	25 - 50 - 80 - 100 - 125 - 160 - 200 - 250 - 320 - 400 - 500 - 600 - 700 - 800 - 900 - 1000
040	25 - 50 - 80 - 100 - 125 - 160 - 200 - 250 - 320 - 400 - 500 - 600 - 700 - 800 - 900 - 1000
050	25 - 50 - 80 - 100 - 125 - 160 - 200 - 250 - 320 - 400 - 500 - 600 - 700 - 800 - 900 - 1000
063	25 - 50 - 80 - 100 - 125 - 160 - 200 - 250 - 320 - 400 - 500 - 600 - 700 - 800 - 900 - 1000

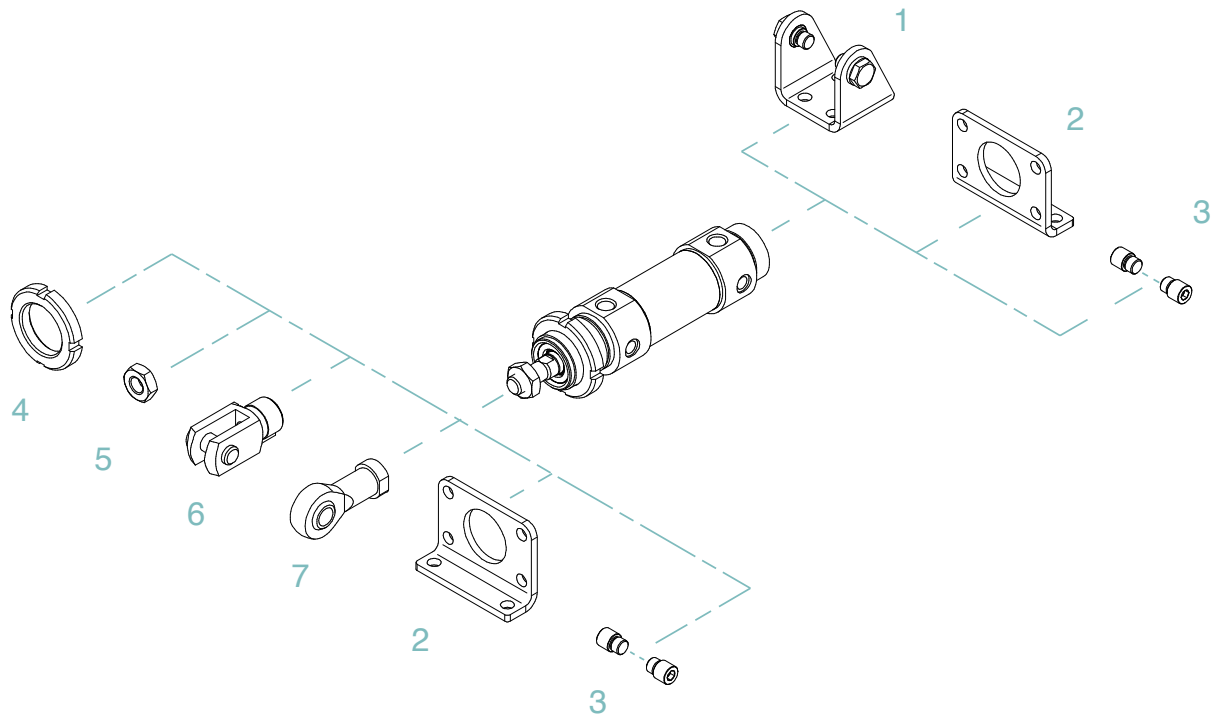
ACCESSORI DI FISSAGGIO CILINDRO TONDO
ROUND CYLINDER MOUNTING PARTS

POS.	CODE	DESCRIZIONE - DESCRIPTION
1	MCFI---	cerniera con viti - hinge with screws
2	MPBI---	pedino flangia - foot flange
3	MPE---	perni - pivots
4	GHI---	ghiera - slotted nut
5	DA--x---	dado stelo - rod nut
6	FC--x---	forcella con clips - clevis with lockable pin
7	SSFI--x---	snodo sferico - rod eye

Dimensioni accessori: vedi sezione SERIE W

Accessories dimensions: see SERIE W chapter